

Sagitta产品特点

- 高质量合金材料.
- 高度可从80mm调整到400mm, 节省空间.
- 合金材质与银色支架将使你的显示屏及工作环境更具现代感.
- 坚固的支架即使载重也能移动顺畅.
- 组合式的配件可依需求选择搭配.
- 内含理线装置, 可将线材隐藏在支架下方.
- 符合VESA标装安装孔位: 75 × 75mm / 100mm × 100mm

夹具式显示屏支架



LA-51-3

(LA-501+LA-511+LA-514)

零件规格图

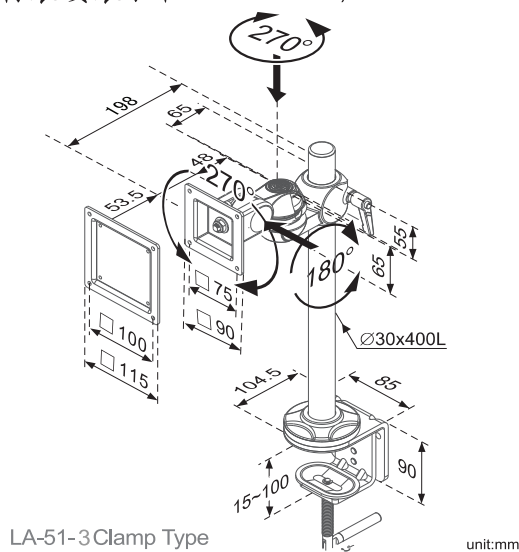

LA-51-3 Clamp Type

unit:mm

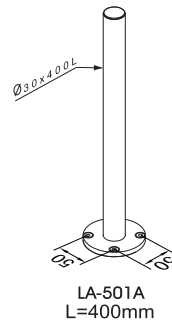

LA-501A
L=400mm

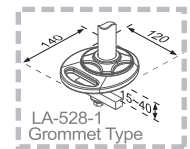

LA-528-1
Grommet Type

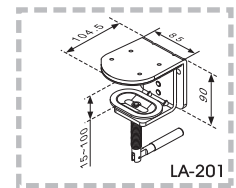

LA-201

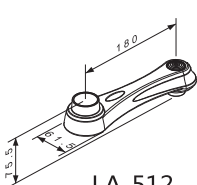

LA-512

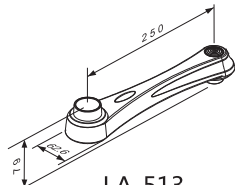

LA-513

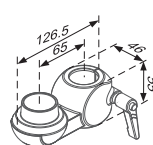

LA-514

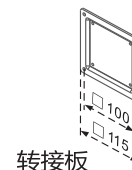

转接板

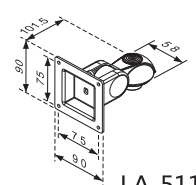

LA-511

产品配件说明表

材质	零组件	LA-501	LA-511	LA-512	LA-513	LA-514	载重量 (KG)
料号		LA-501	LA-511	LA-512	LA-513	LA-514	
型号		a 无缝钢管/银色 b 冷轧板/银色	a 无缝钢管/银色 b ABS塑胶/银色 c 冷轧板/银色	铝合金材质/银色	铝合金材质/银色	铝合金材质/银色	
LA-51-3		1	1			1	12 KGS



公司官网



公众号



产品参数