

## Sagitta系列

### Sagitta产品特点

- 高质量合金材料.
- 高度可从80mm调整到400mm, 节省空间.
- 合金材质与银色支架将使你的显示屏及工作环境更具现代感.
- 坚固的支架即使载重也能移动顺畅.
- 组合式的配件可依需求选择搭配.
- 内含理线装置, 可将线材隐藏在支架下方.
- 符合VESA标装安装孔位: 75 × 75mm / 100mm × 100mm

### 夹具式显示屏支架



**LA-51-2**

(LA-501+LA-511+LA-513+LA-514)

### 零件规格图

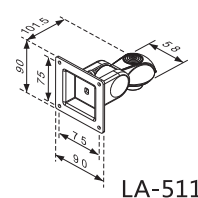
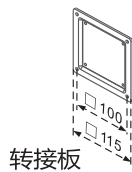
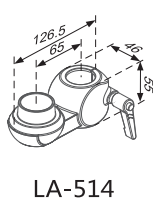
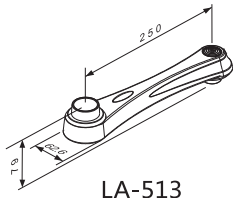
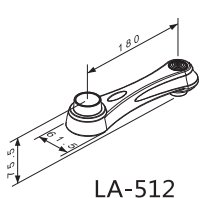
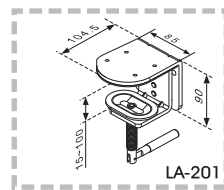
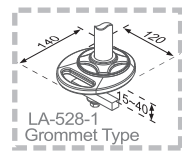
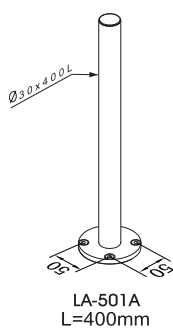
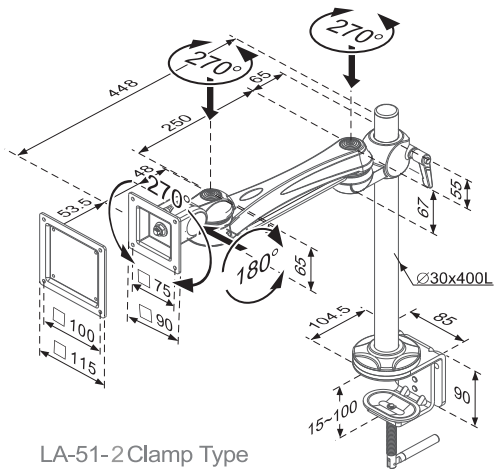

### 产品配件说明表

零组件	材质	料号	型号	载重量(KG)
	a 无缝钢管/银色 b 冷轧板/银色	LA-501		10KGS
	a 铝合金/银色 b ABS塑胶/银色 c 冷轧板/银色	LA-511		
	铝合金/银色	LA-512		
	铝合金/银色	LA-513		
	铝合金/银色	LA-514		
		1	1	1

